

Cub Cadet[®]

Power Equipment

Owner's Manual



**19" ELECTRIC
ROTARY MOWER**

**Model Number
184-387-100**

Important:

Read Safety Rules and Instructions Carefully

Thank you for purchasing an American-built product.

CUB CADET CORPORATION • P.O. BOX 368023 • CLEVELAND, OHIO 44136-9723

IMPORTANT

SAFE OPERATION PRACTICES

THIS SYMBOL POINTS OUT IMPORTANT SAFETY INSTRUCTIONS WHICH, IF NOT FOLLOWED, COULD ENDANGER THE PERSONAL SAFETY AND/OR PROPERTY OF YOURSELF AND OTHERS. READ AND FOLLOW ALL INSTRUCTIONS IN THIS MANUAL BEFORE ATTEMPTING TO OPERATE YOUR ELECTRIC LAWN MOWER. FAILURE TO COMPLY WITH THESE INSTRUCTIONS MAY RESULT IN PERSONAL INJURY. WHEN YOU SEE THIS SYMBOL—  **HEED ITS WARNING.**



DANGER:

Your electric lawn mower was built to be operated according to the rules for safe operation in this manual. As with any type of power equipment, carelessness or error on the part of the operator can result in serious injury. If you violate any of these rules, you may cause serious injury to yourself or others.



TRAINING

1. Read this owner's manual carefully in its entirety before attempting to assemble or operate this machine. Be completely familiar with the controls and the proper use of this machine before operating it. Keep this manual in a safe place for future and regular reference and for ordering replacement parts.
2. Your rotary mower is a precision piece of power equipment, not a plaything. Therefore, exercise extreme caution at all times.
3. Never allow children to operate a power mower. Only persons well acquainted with these rules of safe operation should be allowed to use your mower.
4. No one should operate this unit while intoxicated or while taking medication that impairs the senses or reactions.
5. Keep the area of operation clear of all persons, particularly small children and pets. Stop motor when they are in the vicinity of your mower. Although the area of operation should be completely cleared of foreign objects, an object may have been overlooked and could be accidentally thrown by the mower in any direction and cause serious personal injury to the operator or any others allowed in the area.



PREPARATION

1. Thoroughly inspect the area where the equipment is to be used. Remove all stones, sticks, wire, bones and other foreign objects which could be picked up and thrown by the mower in any direction and cause serious personal injury to the operator or any others allowed in the area.
2. Always wear safety glasses or eye shields during operation or while performing an adjustment or repair, to protect eyes from foreign objects that may be thrown from the machine in any direction.
3. Dress properly. Wear sturdy, rough-soled work shoes. Never operate a unit in barefeet, sandals or sneakers. Do not wear loose clothing or jewelry. They can be caught in moving parts. Use of rubber gloves and footwear is recommended when working outdoors.
4. Never attempt to make a wheel or cutting height adjustment while the motor is running.
5. Mow only in daylight or in good artificial light.
6. Avoid Dangerous Environment—Never operate the equipment in the rain or in damp wet locations. Always be sure of your footing. A slip and fall can cause serious personal injury. Keep a firm hold on the handle and walk, never run. Do not over-reach—keep footing and balance at all times.
7. Warning—To reduce the risk of electric shock hazard, use only with an extension cord suitable for outdoor use. Use only UL approved outdoor extension cords of adequate gauge (minimum 16 gauge recommended) which accept the lawn mower's plug. Extension cords are available at your nearest authorized service center or dealer.
8. Cord sets—Make sure your cord set is in good condition. Use only a 100 foot 14 gauge UL approved outdoor power extension cord (part no. 629-0192 or equivalent). A 50 foot 16 gauge UL approved outdoor extension cord is an acceptable substitute. An undersized cord will cause a drop in line voltage resulting in loss of power and overheating.
9. If extension cord is damaged in any manner while plugged in, disconnect extension cord from wall receptacle.
10. To prevent disconnection of extension cord from mower during operation, be sure to use the cord restraint provided or make a knot as shown in the illustration in next column.

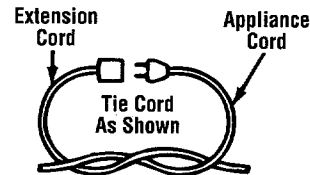

11. Fuses—The mower should be operated on a 15 or 20 AMP circuit. If difficulty in starting is experienced with a standard 15 AMP fuse or circuit breaker, contact your nearest authorized service location. Do not use a higher rated fuse without consulting your power company.
12. For your safety, use the slope gauge included as part of this manual to measure slopes before operating this unit on a sloped or hilly area. If the slope is greater than 15° as shown on the slope gauge, do not operate this unit on that area or serious injury could result.

OPERATION

1. Avoid accidental starting. Do not pull plugged-in lawn mower with finger on switch. Be sure switch is **off** when plugging in.
2. Do not abuse cord—never pull lawn mower by cord or yank it to disconnect from receptacle. Keep cord from heat, oil, and sharp edges.
3. Do not put hands or feet near or under rotating parts. Keep clear of the discharge opening at all times as the rotating blade can cause injury.
4. Stop the motor when you leave the mower and before crossing gravel drives, walks or roads.
5. After striking a foreign object, shut off the motor, make absolutely sure the blade and all moving parts have completely stopped, disconnect the power cord to prevent accidental starting, then thoroughly inspect the mower for any damage. Such damage must be repaired before restarting and operating the mower.
6. If the equipment should start to vibrate abnormally, stop the motor and check immediately for the cause. Vibration is generally a warning of trouble.
7. Stop the motor, unplug the power cord, and wait for the blade and all moving parts to stop before cleaning or unclogging, repairing or inspecting the mower. The cutting blade continues to rotate for a few seconds after the motor is shut off.
8. Do not force lawn mower. It will do the job better and safer at the rate for which it was designed. Use right appliance—Do not use lawn mower for any job except that for which it is intended.
9. Mow across the face of slopes, never up-and-down. Never cut grass by pulling mower toward you. Exercise extreme caution when operating mower on uneven terrain or changing direction on slopes. Do not mow excessively steep slopes. Always be sure of your footing. A slip and fall can cause serious personal injury.
10. Never operate mower without proper guards, plates or other safety protective devices in place.
11. **The blade/motor control on this mower is installed to minimize the risk of blade contact injury and is required by federal regulations. Do not under any circumstances attempt to defeat the function of the blade/motor control.**
12. To avoid electric shock hazard, never push mower over cord. Do not mow around the lawn in circles. Always travel back and forth across the lawn, beginning at the point nearest the electric outlet to which the extension cord is connected. This will keep the cord on the mowed area of the lawn and out of the way.
13. Do not operate mower after it has been dropped or damaged in any manner. Return mower to nearest authorized service location.

SAFE OPERATION PRACTICES (Continued)

- The use of accessory attachments not recommended by the mower manufacturer may cause hazards.
- Do not operate this mower with the chute door open, unless the complete grass catcher is properly mounted on the mower.

MAINTENANCE AND STORAGE

- Warning—Disconnect power cord from electrical outlet before performing any maintenance or service on mower.
- Check the blade and motor mounting bolts at frequent intervals for proper tightness. Keep all nuts, bolts, and screws tight to be sure the equipment is in safe working condition.
- Keep blade sharp.
- Use identical replacement blades only. Replace damaged cord.
- To reduce fire hazard, keep the motor free of grass, leaves, or excessive grease.
- Store idle lawn mower indoors when not in use. Allow motor to cool before storing in any enclosure. Lawn mower should be stored indoors in dry, high or locked-up place, out of reach of children.
- Maintain lawn mower with care. Keep blade sharp and clean for best and safest performance. Follow instructions for lubricating and changing accessories.

- Check the grass catcher bag frequently for wear or deterioration. Replace a worn or damaged bag immediately. Be sure replacement bag meets original equipment specifications.

DOUBLE INSULATED LAWN MOWER

DOUBLE INSULATION IS A CONCEPT IN SAFETY IN ELECTRIC LAWN MOWERS, WHICH ELIMINATES THE NEED FOR THE USUAL THREE WIRE GROUNDED POWER CORD AND GROUNDED SUPPLY SYSTEM. WHEREVER THERE IS ELECTRIC CURRENT IN THE MOWER, THERE ARE TWO COMPLETE SETS OF INSULATION TO PROTECT THE USER. ALL EXPOSED METAL PARTS ARE ISOLATED FROM THE INTERNAL METAL MOTOR COMPONENTS WITH PROTECTING INSULATION.

IMPORTANT—SERVICING OF A LAWN MOWER WITH DOUBLE INSULATION REQUIRES EXTREME CARE AND KNOWLEDGE OF THE SYSTEM AND SHOULD BE PERFORMED ONLY BY A QUALIFIED SERVICE TECHNICIAN. FOR SERVICE WE SUGGEST YOU RETURN THE LAWN MOWER TO YOUR NEAREST AUTHORIZED SERVICE DEALER FOR REPAIR. ALWAYS USE ORIGINAL FACTORY REPLACEMENT PARTS WHEN SERVICING.

SET-UP INSTRUCTIONS

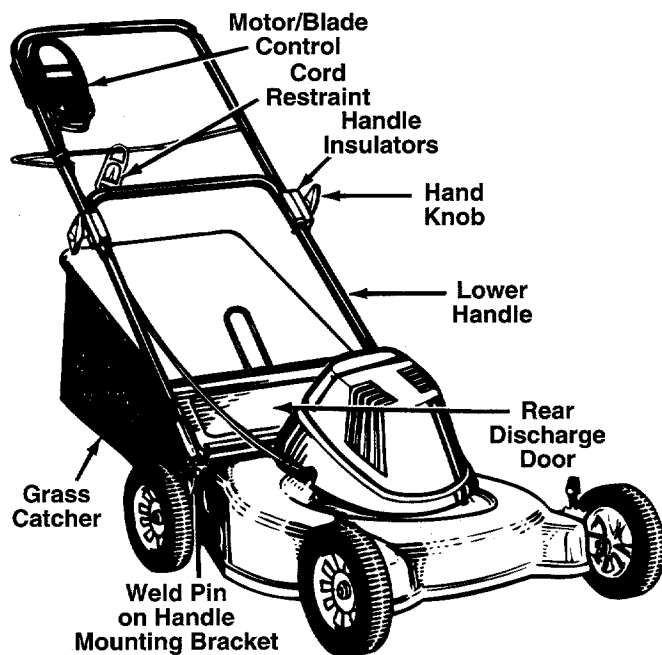

FIGURE 1.

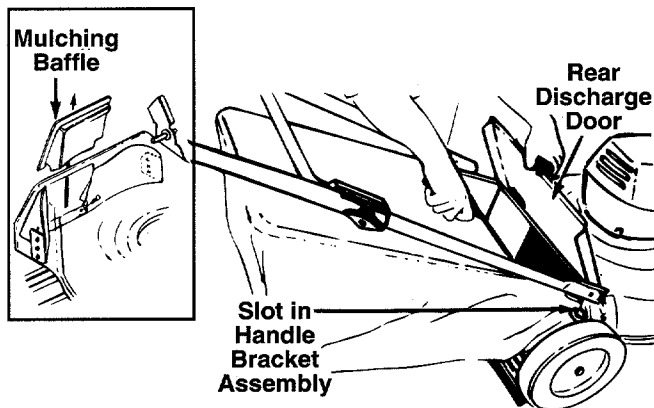

FIGURE 2.

TO REMOVE MOWER FROM CARTON

Remove the carton inserts. Lift the mower from the carton, or cut the corners of the carton and roll the mower out. Make certain all parts and literature have been removed from the carton before the carton is discarded.

HOW TO SET-UP YOUR MOWER

- Pull up and back on the lower handle. Pivot the upper handle up to raise the handle into the operating position. See figure 1.
- The upper handle may be adjusted to three different height positions. To select desired position, align one of the three marks on the top of the lower handle insulators with the mark on the upper handle insulators. Tighten the hand knobs.
- Remove the hairpin clips from the outer hole in the weld pins on the handle mounting brackets. Place the hairpin clips in the inner hole.

ATTACHING GRASS CATCHER TO MOWER

Your mower has been shipped with the mulching baffle in place on the mower. To attach the grass catcher, proceed as follows.

- Lift the rear discharge door on the mower. Remove the mulching baffle. See figure 2, inset.
- Place the hooks on the grass catcher into the slots in the handle bracket assemblies. See figure 2. Release the rear discharge door.

To remove the grass catcher, lift the rear discharge door on the mower. Lift the grass catcher up, out of the slots in the handle bracket assemblies. Release the rear discharge door.



WARNING: Never operate the mower unless the hooks on the grass catcher are seated in the slots on the handle bracket assemblies, and the rear discharge door rests firmly against the top of the grass catcher

OPERATION



FIGURE 3.

Keep hands and feet away from the chute area on mowing deck. See figure 3.

The operation of any lawn mower can result in foreign objects being thrown into the eyes, which can result in severe eye damage. Always wear safety glasses or eye shields. We recommend wide vision safety mask for over spectacles or standard safety glasses.



NOTE: The wheels on your unit are set in a low cutting height position for shipping purposes. For best results, raise the cutting position until it is determined which height is best for your lawn. See cutting height adjustment.

MOTOR/BLADE CONTROL



WARNING: This control mechanism is a safety device. Never attempt to bypass its operations.

The motor/blade control is located on the upper handle of the mower. See figure 4. The motor/blade control handle engages and disengages the motor and blade.

CORD CONNECTION



WARNING: Use only a 100 foot 14 gauge UL approved outdoor power extension cord (part no. 629-0192 or equivalent). A 50 foot 16 gauge UL approved outdoor extension cord is an acceptable substitute. Using any other length or rating of cord will diminish the performance and possibly the life of the electric motor.

Cord Restraint

Attach extension cord (not provided with unit) to the cord restraint as follows. Form a small loop in the extension cord. Allow enough excess cord to make the connection to the motor/blade control (approximately 20 inches). Slip the loop through the slot on the bottom of the cord restraint, and up over the tab, to prevent disconnection from the motor/blade control during operation. Keep the cord restraint as close to the motor/blade control as possible. See figure 4.

Connection to the Motor/Blade Control

To attach extension cord to the mower, swing open the spring-loaded plug retainer located beneath the motor/blade control. Connect the plug on the extension cord fully onto the plug on the mower. The mower is equipped with a polarized AC power plug (one blade of the plug is wider than the other), which will fit into the plug on the extension cord only one way. See figure 4, inset. If unable to make a full connection, try reversing the plug on the extension cord. Should the plugs still fail to fit, contact your service dealer for assistance. Do not defeat the safety purpose of the polarized plug.

Connection to the Electric Power Source

Plug the extension cord into any convenient 110-120 volt 60 cycle A.C. outlet or receptacle for your source of power. This outlet may be located either out-of-doors or indoors. If an inside receptacle is used, the extension cord can be taken out either through the doorway or a window. To avoid blowing fuses, pick an outlet that is not overloaded. Your mower will operate satisfactorily on a circuit that is fused for 15 amperes. Do not use oversize fuses without consulting your power company.

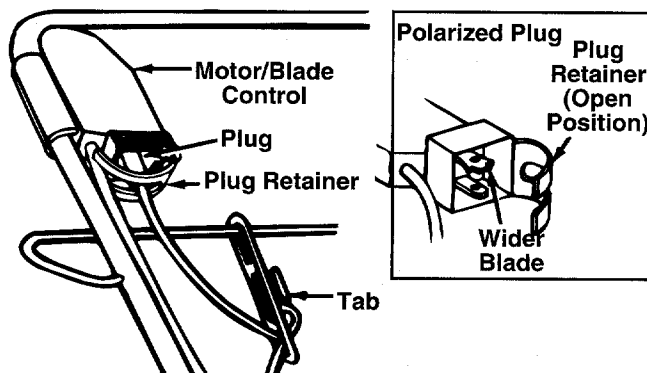

FIGURE 4.

TO START MOTOR AND ENGAGE BLADE

Standing behind the unit, lift the motor/blade control handle with the left forefinger, then pull handle up and hold it against the upper handle with right hand. See figure 5.

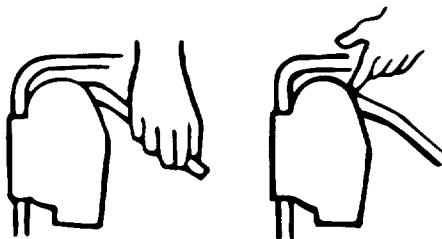

FIGURE 5.

TO STOP MOTOR AND BLADE

1. Release the motor/blade control handle to stop the engine and blade. (A high pitched noise will result, which is the result of deceleration of the electric motor. Sparking at the top of motor is also normal during deceleration.)



WARNING: The blade continues to rotate for a few seconds after the motor is shut off. If motor does not come to an immediate stop when the motor/blade control handle is released, contact an authorized service location.

2. Disconnect the power source to prevent accidental starting while equipment is unattended.

USING YOUR ROTARY MOWER



WARNING: Do not operate this mower with the chute door open, unless the complete grass catcher is properly mounted on the mower.

Be sure that lawn is clear of stones, sticks, wires, or other objects which could damage lawn mower or engine. Such objects could be accidentally thrown by the mower in any direction and cause serious personal injury to the operator and others.

To prevent electric shock, do not operate the mower in damp or wet locations.

Never mow around the lawn in circles. Always travel back and forth across the lawn, beginning at the point nearest the electric outlet where cord is connected. See figure 6. Cut grass moving away from the outlet so the cord lies in the cut portion of the lawn, out of the way.

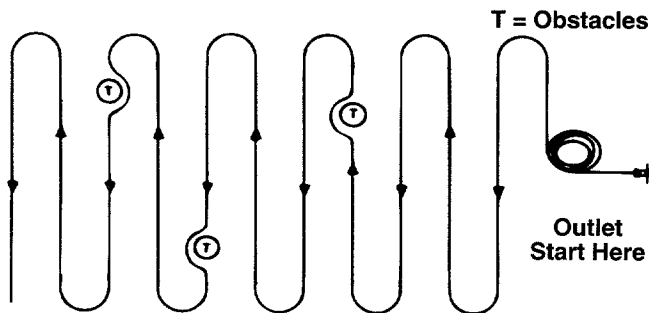

FIGURE 6.—Mowing Procedure

Do not allow extension cord to wrap around trees, shrubs or other obstacles. When picking up the extension cord, wind the cord in a series of equal loops on each side of your hand to prevent snarling. See illustration at right.



To cut heavy grass, reduce walking speed to allow more effective cut and proper discharge of the clippings. For best results, always cut off one-third or less of the total length of the grass. The average lawn should be approximately 1-1/2 to 2 inches during the cool season, and over 2 inches during hot months. For a healthier and better looking lawn, cut more often and after moderate growth. The lawn should be cut in the fall as long as there is growth.



WARNING: If you strike a foreign object, stop the motor. Disconnect the power source, thoroughly inspect the mower for any damage, and repair the damage before restarting and operating the mower. Extensive vibration of the mower during operation is an indication of damage. The unit should be promptly inspected and repaired.

USING THE MULCHER

For effective mulching, do not cut wet grass because it tends to stick to the underside of the deck, preventing proper mulching of grass clippings. New or thick grass may require a narrower cut. The ground speed should be adjusted to the condition of the lawn. If mowing has been delayed and the grass has been allowed to grow in excess of 4", mulching is not recommended. Mow using the grass bag to reduce the grass height to 3-1/4" maximum before mulching.

CUTTING HEIGHT ADJUSTMENT



WARNING: Do not at any time make any adjustment to lawn mower without first stopping motor and disconnecting the power source.

A height adjustment lever at each wheel provides cutting height adjustment. Each adjuster has nine height positions. Height of cut will be changed when the lever is moved from one position to another. Simply depress the lever towards wheel and move wheel and lever assembly to desired position. See figure 7. All wheels must be placed in the same relative position. For rough or uneven lawns, move the wheels to a position which will give a higher cutting height.

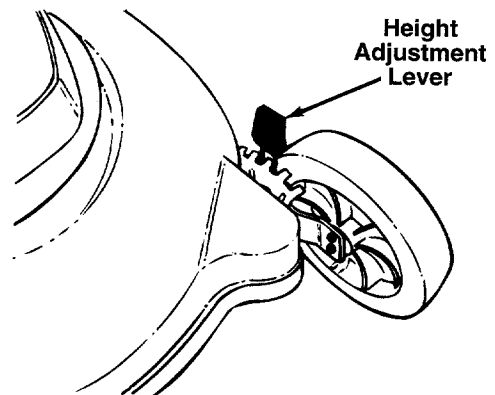

FIGURE 7.

MAINTENANCE



WARNING: Always stop motor and disconnect the power source before cleaning, lubricating or performing any repairs or maintenance on lawn mower.

LUBRICATION

Wheels—Wheels require no lubrication. However, if the wheels are removed for any reason, lubricate the surface of the axle and the inner surface of the wheel with light oil. Engine oil may also be used.

CUTTING BLADE



WARNING: Always protect hands by wearing heavy gloves and/or wrapping cutting edges with newspapers or other materials when performing any blade maintenance. Be certain to disconnect the power supply.

Remove the bolt and bell washer which hold the blade and adapter to the motor shaft. Remove the blade and adapter from the shaft. If the blade or blade adapter needs replacing, remove the two small bolts, lock washers and nuts which hold the blade to the adapter.



WARNING: Periodically inspect the blade adapter for cracks, especially if you strike a foreign object. Replace when necessary.

When sharpening the blade, follow the original angle of grind as a guide. It is **extremely important** that each cutting edge receives an equal amount of grinding to prevent an unbalanced blade. An unbalanced blade will cause excessive vibration when rotating at high speeds, may cause damage to the mower and could break, causing personal injury.

It is recommended that the blade always be removed from the adapter for the best test of balance.

The blade can be tested by balancing it on a round shaft screwdriver. Remove metal from the heavy side until it balances evenly.

Before reassembling the blade and the blade adapter to the unit, lubricate the motor shaft and the inner surface of the blade adapter with light oil. Lubricating the bolt holes, bolts and inner surface of the nuts with light oil is also recommended. Engine oil may also be used.

When replacing the blade, be sure to install the blade with the side of the blade marked "Bottom" (or with part number) facing the ground when the mower is in the operating position.

NOTE: The use of any accessory on this Rotary Mower other than those manufactured by the mower manufacturer is **not** recommended.



WARNING: DO NOT operate the mower without the entire grass catcher or rear discharge door in place. DO NOT operate the mower without the protective shield on the rear of the deck in place.

NOTE: Under normal usage bag material is subject to wear and should be checked periodically. Be sure any replacement bag complies with the mower manufacturer's recommendations.

Blade Mounting Torque

All blade bolts: 450 in. lbs. min., 600 in. lbs. max.

To insure safe operation of your unit, **all** nuts and bolts must be checked periodically for correct tightness.

DECK

Remove any buildup of grass and leaves on or around the motor cover (do not use water). Wipe mower clean with a dry cloth occasionally.

The underside of mower deck should be cleaned after each use as grass clippings, leaves, dirt and other matter will accumulate. This accumulation of grass clippings, etc., is undesirable as it will promote rust and corrosion.

Disconnect the power source. Tilt the mower forward or on its side and scrape clean with a suitable tool.



WARNING: To reduce the risk of electric shock, do not expose to water.

OFF-SEASON STORAGE

1. Make certain motor/blade control switch is in OFF position and power supply is disconnected.
2. Clean mower as instructed in previous section.
3. Wipe extension cord to remove any foreign substance such as oil or stains. Replace extension cord if cut or damaged in any way.
4. Wind cord as shown on page 5.
5. Store mower indoors, in a cool, dry place, out of reach of children. Do not cover lawn mower with a solid plastic sheet. Trapping moisture around the mower will promote rust and corrosion.

REPLACEMENT PARTS

The only way to insure the performance of your product is to use original equipment parts and accessories. White Outdoor Products designs and engineers quality parts to exacting specifications. When you substitute, you take a chance on quality, reliability, safety and performance. Use White Outdoor Products original equipment parts—See your local White Outdoor dealer!

Extension Cord (100 foot)	629-0192
Cord Restraint	725-1590
Cord & Switch Ass'y. Comp.	624-0032
Mulching Blade 19"	742-0719
Blade Adapter	748-0356
Grass Bag	764-0446

SLOPE GAUGE

USE THIS PAGE AS A GUIDE TO DETERMINE SLOPES WHERE YOU MAY NOT OPERATE SAFELY.

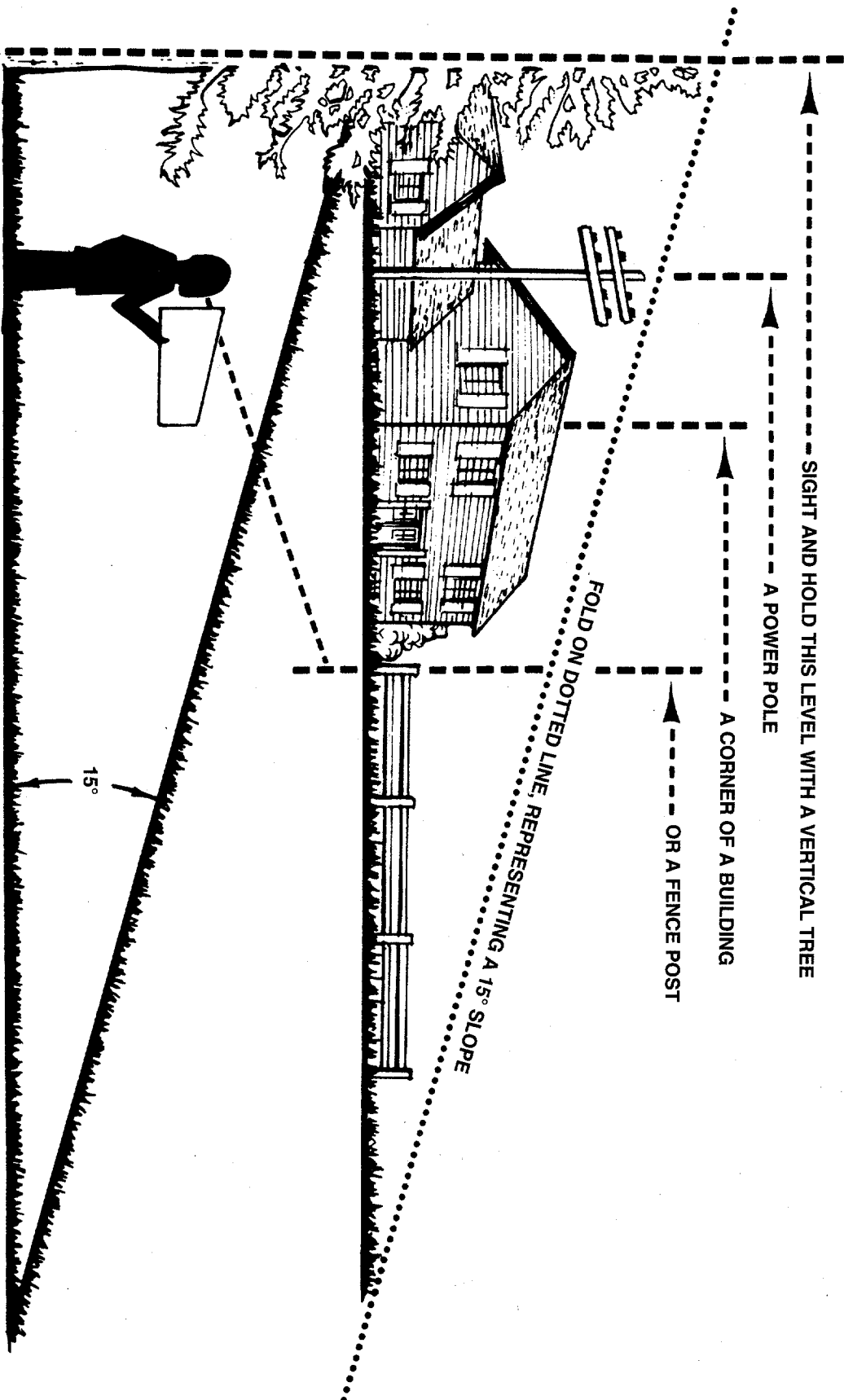

Do not mow on inclines with a slope in excess of 15 degrees (a rise of approximately 2-1/2 feet every 10 feet). A riding mower could overturn and cause serious injury. If operating a walk-behind mower on such a slope, it is extremely difficult to maintain your footing and you could slip, resulting in serious injury.

Operate RIDING mowers up and down slopes, never across the face of slopes.

Operate WALK-BEHIND mowers across the face of slopes, never up and down slopes.



Power Equipment

LIMITED WARRANTY

TWO-YEAR RESIDENTIAL

ONE-YEAR COMMERCIAL

Proper maintenance of your Cub Cadet equipment is the owner's responsibility. Follow the instructions in your owner's manual for correct lubricants and maintenance schedule. Your Cub Cadet dealer carries a complete line of quality lubricants and filters for your equipment's engine, transmission, chassis and attachments.

RIDING MOWERS, LAWN TRACTORS, GARDEN TRACTORS, CUB CADET ATTACHMENTS AND HOME MAINTENANCE PRODUCTS

This limited warranty for residential users, covers any defect in materials or workmanship in your Cub Cadet equipment for two years from the date of purchase for the first user purchaser.

We will replace or repair any part or parts without charge through your authorized Cub Cadet dealer.

Batteries have a one-year prorated limited warranty with 100% replacement during the first three months.

V-belts for either the traction drive or any attachments are covered for one year only.

Cub Cadet equipment used commercially is warranted for one year only.

(Commercial use is defined as either having hired operators or used for income producing purpose.)

ITEMS NOT COVERED

The warranty does not cover routine maintenance items such as lubricants, filters (oil, fuel, air and hydraulic), cleaning, tune-ups, brake and/or clutch inspection, adjustments made as part of normal maintenance, blade sharpening, set-up, abuse, accidents and normal wear. It does not cover incidental costs such as transporting your equipment to and from the dealer, telephone charges or renting a product temporarily to replace a warranted product.

There is no other express warranty.

HOW TO OBTAIN SERVICE

Contact your authorized Cub Cadet servicing dealer who sold you your Cub Cadet equipment. If this dealer is not available, see the Consumer Yellow Pages under "lawn mowers" for the name of a dealer near you.

If you need further assistance in finding an authorized Cub Cadet servicing dealer, contact:

Cub Cadet Corporation
Post Office Box 368023
Cleveland, Ohio 44136-9723

HOW DOES STATE LAW APPLY?

This limited warranty gives you specific legal rights, and you may also have other rights which vary from state to state.